

Abgleich-Anleitung

AM-Signal: Modulationsfrequenz 400 Hz, 30% mod.; FM-Signal: Modulationsfrequenz 800 Hz, 40 kHz Hub.
 Die Empfindlichkeitswerte sind auf eine Gesamtleistung (an allen 3 Lautsprechern) von 50 mW bezogen.
 Für diese Gesamtleistung sind zu messen:
 Bei 400 Hz am Tiefton-Lautsprecher (3 Ω) = 275 mV,
 an jedem Seitenlautsprecher (5 Ω) = 270 mV;
 bei 800 Hz am Tiefton-Lautsprecher (3 Ω) = 180 mV,
 an jedem Seitenlautsprecher (5 Ω) = 320 mV.

AM-ZF-Abgleich 460 kHz

Bereich Drehko-Stellung	Ankopplung des Meßsenders	Abgleich	Empfindlichkeit	Bemerkungen
MW, Zeiger auf 1 MHz	G ₁ EF 89	(I) und (II) Maximum	1 mV	Mit wechselseitiger Bedämpfung (10 kΩ und 5 nF in Reihe) abgleichen. ZF-Trennschärfe 1:110 ZF-Bandbreite 4,5 kHz
	G ₁ ECH 81	(III) und (IV) Maximum	14 μV	
MW, eingedreht	an Antenne	(V) inneres Minimum		

AM-Oszillator- und Vorkreisabgleich

Bereich Frequenz Zeigerstellung	Oszillator	Außenantennen-Vorkreis	Empfindlichkeit μV	Spiegel-selektion 1:	Ferrit-antennen-Vorkreis	Empfindlichkeit μV/m	Schwingstrom μA	Bemerkungen
MW	560 kHz (1) Maximum	inneres (4) Maximum	6 ...	450	(8) Maximum	50 ...	300 ...	Zeigeranschlag auf 1 von „510 kHz“ Nach dem Außenantennen-Vorkreisabgleich, Ferritantenne LW abgleichen, dann MW Mischempfindlichkeit bei 1 MHz an G ₁ ECH 81 : 17 μV
	1450 kHz (2) Maximum	(5) Maximum	... 6 ...	280	(9) Maximum	... 40	... 340	
LW	160 kHz (3) Maximum	äußeres (6) Maximum	8 ... 6	2400 1100 580	(7) Maximum	150 ...	350 430	
KW	8 MHz (10) Maximum	(11) Maximum	16 ... 13	11 10 9			260 240	

FM-ZF-Abgleich 10,7 MHz

Meßsender-Modulation	Ankopplung des Meßsenders	Abgleich	Abgleichsanzeige	Empfindlichkeit	Bemerkungen
AM, FM oder unmoduliert	G ₁ EF 89	(a) Maximum	Röhrenvoltmeter an C 45; Outputmeter bei FM	7 mV	Statt Röhrenvoltmeter kann ein mA-Meter (0,1 ... 1 mA) mit R 27 in Serie geschaltet werden. Diskriminator-Abgleich mit ca 500 mV ZF an G ₁ EF 89
AM		(b) Minimum	Outputmeter; Röhrenvoltmeter an C 45		
AM, FM oder unmoduliert	G ₁ ECH 81	(c) Maximum (d) Maximum	Röhrenvoltmeter an C 45; Outputmeter bei FM	180 μV	
	Drahting ECC 85 oder über 0,5 pF am Punkt (X)	(e) inneres Maximum (f) Maximum			

FM-Oszillator-, Zwischen- und Antennenkreis-Abgleich

Meßsender-Frequenz, Zeigerstellung	Oszillator	Zwischenkreis	Antennenkreis	Abgleichsanzeige	Schwingspannung	Empfindlichkeit (Rauschzahl)	Bemerkungen
88 MHz	(A) Maximum	(B) Maximum	* (E) Maximum	Outputmeter (bei AM oder ohne Mod. mit RV an C 45)	2,1 ... 2,4 V _{eff}	< 3 kTo	* Da der Kreis (E) sehr breit ist, wird der Kern 2,5 mm unter dem oberen Spulenkörpertrand eingestellt.
102 MHz	(C) Maximum	(D) Maximum					

Brumm: Lautstärkereger zu: 1,5 mV; auf: 3 mV — NF-Empfindlichkeit (400 Hz) am Spannungsteiler: 23 mV

AM-Spulensatz von unten gesehen

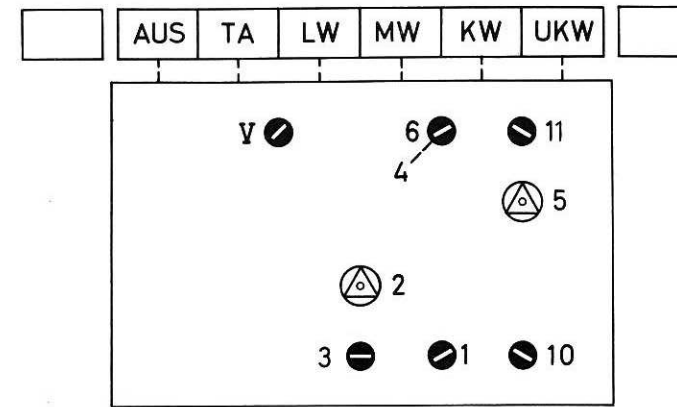

Zum Abgleich von Kern 4 wird Kern 6 entfernt.

FM-Spulensatz von unten gesehen

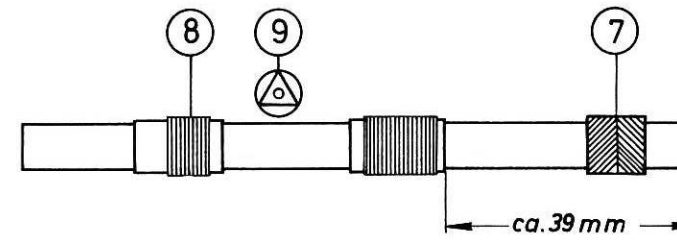
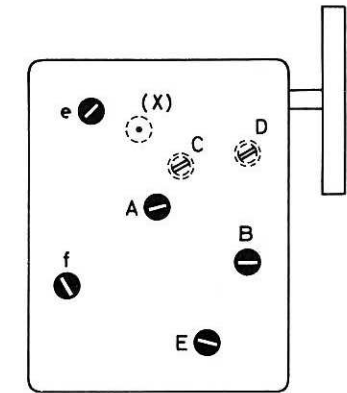

Ferritstab-Antenne

F I 7207—348

F II 7207—328

Filter-Rückansicht

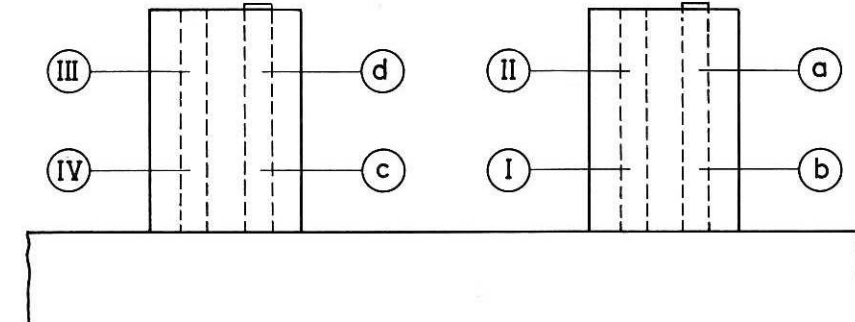

AM-Antrieb von der Skalenseite gesehen

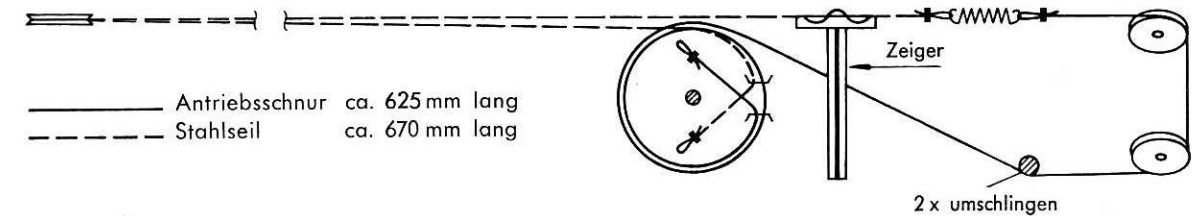

FM-Antrieb von der Skalenseite gesehen

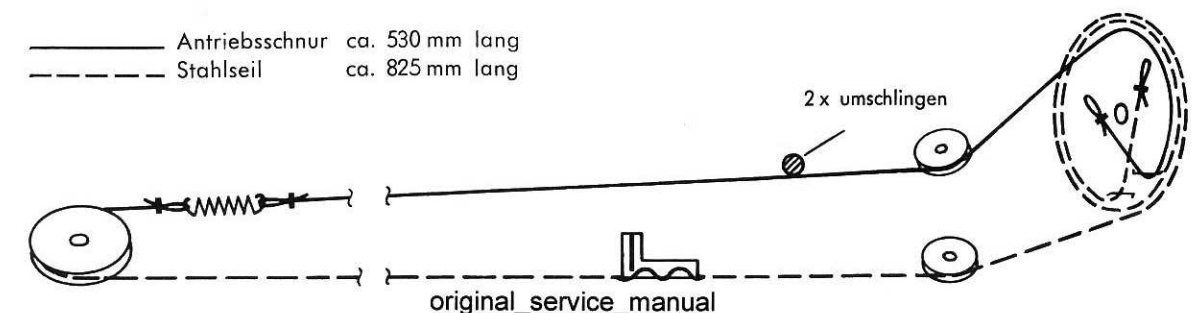

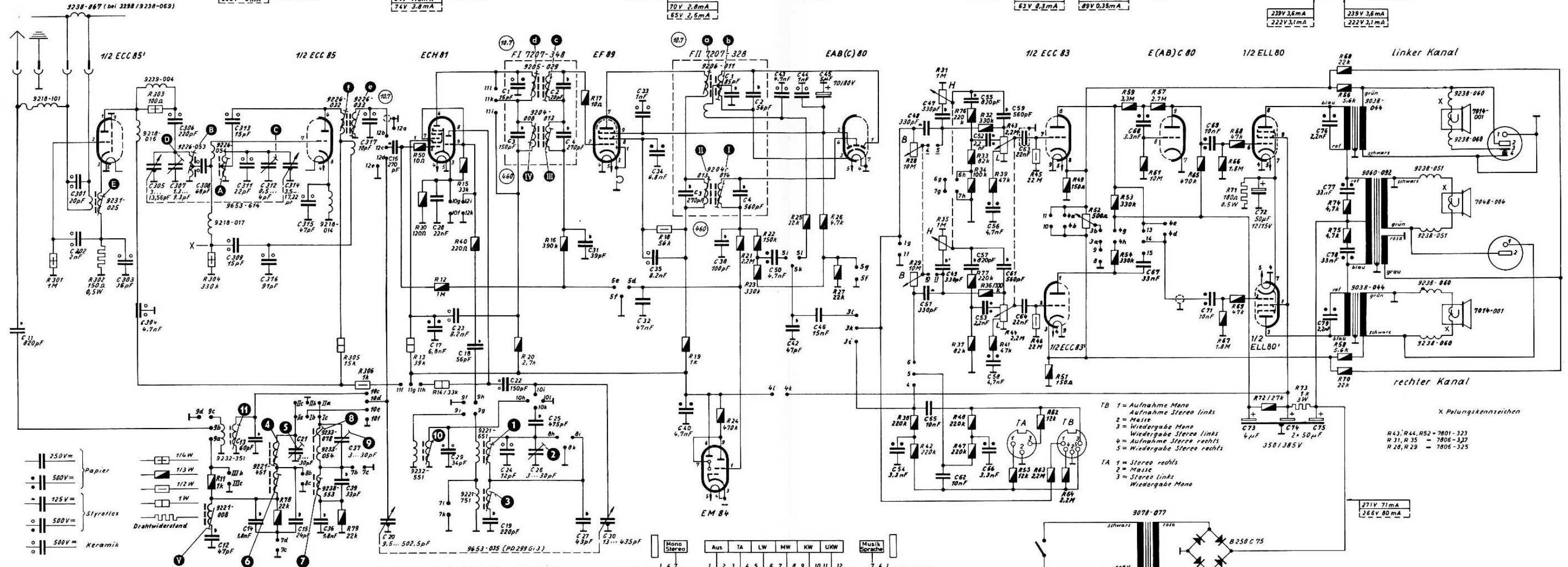
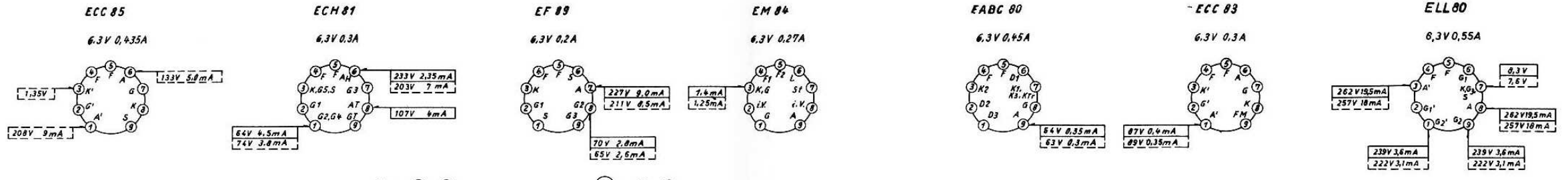

- 250V = Papier
- 500V = Styrolux
- 500V = Keramik

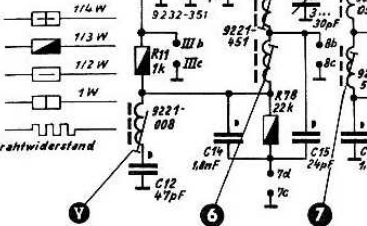

FM-Spulensatz Nr. 7435-034 ZF 10,7 MHz
 AM-Spulensatz Nr. 7415-116.01 ZF 460 kHz

Spannungen mit Grundig-Röhrenvoltmeter gemessen. Mehrwerte gelten bei MW/DKW ohne Signal an der Antenne.

Wellenbereiche: LW 145 ... 350 kHz
 MW 510 ... 1620 kHz
 KW 5,9 ... 16 MHz
 UKW 87 ... 104 MHz

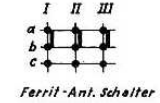

Änderungen vorbehalten

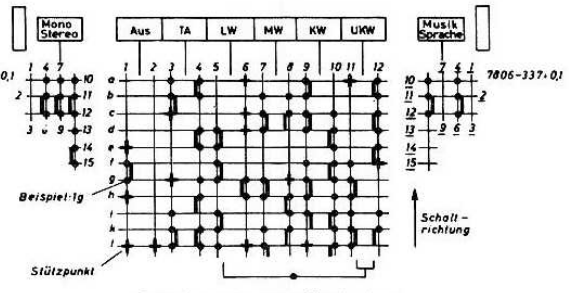

- TB 1 = Aufnahme Mono
- 2 = Aufnahme Stereo links
- 3 = Wiedergabe Mono
- 4 = Aufnahme Stereo rechts
- 5 = Wiedergabe Stereo rechts
- TA 1 = Stereo rechts
- 2 = Masse
- 3 = Stereo links
- Wiedergabe Mono

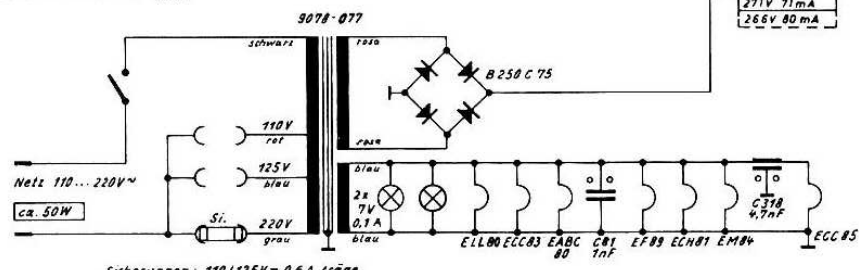

C:	11, 301, 302, 303, 304, 305, 306, 307, 308, 309, 311, 312, 316, 317, 318, 319, 320, 321, 322, 323, 324, 325, 326, 327, 328, 329, 330, 331, 332, 333, 334, 335, 336, 337, 338, 339, 340, 341, 342, 343, 344, 345, 346, 347, 348, 349, 350, 351, 352, 353, 354, 355, 356, 357, 358, 359, 360, 361, 362, 363, 364, 365, 366, 367, 368, 369, 370, 371, 372, 373, 374, 375, 376, 377, 378, 379, 380, 381, 382, 383, 384, 385, 386, 387, 388, 389, 390, 391, 392, 393, 394, 395, 396, 397, 398, 399, 400, 401, 402, 403, 404, 405, 406, 407, 408, 409, 410, 411, 412, 413, 414, 415, 416, 417, 418, 419, 420, 421, 422, 423, 424, 425, 426, 427, 428, 429, 430, 431, 432, 433, 434, 435, 436, 437, 438, 439, 440, 441, 442, 443, 444, 445, 446, 447, 448, 449, 450, 451, 452, 453, 454, 455, 456, 457, 458, 459, 460, 461, 462, 463, 464, 465, 466, 467, 468, 469, 470, 471, 472, 473, 474, 475, 476, 477, 478, 479, 480, 481, 482, 483, 484, 485, 486, 487, 488, 489, 490, 491, 492, 493, 494, 495, 496, 497, 498, 499, 500, 501, 502, 503, 504, 505, 506, 507, 508, 509, 510, 511, 512, 513, 514, 515, 516, 517, 518, 519, 520, 521, 522, 523, 524, 525, 526, 527, 528, 529, 530, 531, 532, 533, 534, 535, 536, 537, 538, 539, 540, 541, 542, 543, 544, 545, 546, 547, 548, 549, 550, 551, 552, 553, 554, 555, 556, 557, 558, 559, 560, 561, 562, 563, 564, 565, 566, 567, 568, 569, 570, 571, 572, 573, 574, 575, 576, 577, 578, 579, 580, 581, 582, 583, 584, 585, 586, 587, 588, 589, 590, 591, 592, 593, 594, 595, 596, 597, 598, 599, 600, 601, 602, 603, 604, 605, 606, 607, 608, 609, 610, 611, 612, 613, 614, 615, 616, 617, 618, 619, 620, 621, 622, 623, 624, 625, 626, 627, 628, 629, 630, 631, 632, 633, 634, 635, 636, 637, 638, 639, 640, 641, 642, 643, 644, 645, 646, 647, 648, 649, 650, 651, 652, 653, 654, 655, 656, 657, 658, 659, 660, 661, 662, 663, 664, 665, 666, 667, 668, 669, 670, 671, 672, 673, 674, 675, 676, 677, 678, 679, 680, 681, 682, 683, 684, 685, 686, 687, 688, 689, 690, 691, 692, 693, 694, 695, 696, 697, 698, 699, 700, 701, 702, 703, 704, 705, 706, 707, 708, 709, 710, 711, 712, 713, 714, 715, 716, 717, 718, 719, 720, 721, 722, 723, 724, 725, 726, 727, 728, 729, 730, 731, 732, 733, 734, 735, 736, 737, 738, 739, 740, 741, 742, 743, 744, 745, 746, 747, 748, 749, 750, 751, 752, 753, 754, 755, 756, 757, 758, 759, 760, 761, 762, 763, 764, 765, 766, 767, 768, 769, 770, 771, 772, 773, 774, 775, 776, 777, 778, 779, 780, 781, 782, 783, 784, 785, 786, 787, 788, 789, 790, 791, 792, 793, 794, 795, 796, 797, 798, 799, 800, 801, 802, 803, 804, 805, 806, 807, 808, 809, 810, 811, 812, 813, 814, 815, 816, 817, 818, 819, 820, 821, 822, 823, 824, 825, 826, 827, 828, 829, 830, 831, 832, 833, 834, 835, 836, 837, 838, 839, 840, 841, 842, 843, 844, 845, 846, 847, 848, 849, 850, 851, 852, 853, 854, 855, 856, 857, 858, 859, 860, 861, 862, 863, 864, 865, 866, 867, 868, 869, 870, 871, 872, 873, 874, 875, 876, 877, 878, 879, 880, 881, 882, 883, 884, 885, 886, 887, 888, 889, 890, 891, 892, 893, 894, 895, 896, 897, 898, 899, 900, 901, 902, 903, 904, 905, 906, 907, 908, 909, 910, 911, 912, 913, 914, 915, 916, 917, 918, 919, 920, 921, 922, 923, 924, 925, 926, 927, 928, 929, 930, 931, 932, 933, 934, 935, 936, 937, 938, 939, 940, 941, 942, 943, 944, 945, 946, 947, 948, 949, 950, 951, 952, 953, 954, 955, 956, 957, 958, 959, 960, 961, 962, 963, 964, 965, 966, 967, 968, 969, 970, 971, 972, 973, 974, 975, 976, 977, 978, 979, 980, 981, 982, 983, 984, 985, 986, 987, 988, 989, 990, 991, 992, 993, 994, 995, 996, 997, 998, 999, 1000.
----	--

GRUNDIG WERKE FÜRTH (BAY.)

**Schaltplan 3295 Stereo
 3298 Stereo**

(11-1213-1101)